

# 6500V/ $\mu$ s, Wideband, High-Output-Current, Single-Ended-to-Differential Line Drivers with Enable

## General Description

The MAX4447/MAX4448/MAX4449 single-ended-to-differential line drivers are designed for high-speed communications. Using current feedback for greater bandwidth, these devices deliver full-power bandwidths up to 405MHz and feature slew rates as high as 6500V/ $\mu$ s. The MAX4447 has a fixed gain of +2V/V and a small-signal bandwidth of 430MHz. The MAX4448/MAX4449 have small-signal bandwidths of 330MHz and 400MHz, respectively, and are internally compensated for minimum gain configurations of +2V/V and +5V/V, respectively. For greater design flexibility, the MAX4448/MAX4449 allow for variable gain selection using external gain-setting resistors. A low-power enable mode reduces current consumption below 5.5mA and places the outputs in a high-impedance state.

The MAX4447/MAX4448/MAX4449 can deliver differential output swings of  $\pm 6.2$ V from  $\pm 5$ V supplies with a 50 $\Omega$  load. Excellent differential gain/phase and noise specifications make these amplifiers ideal for a wide variety of video and RF signal-processing and transmission applications.

## Applications

Differential Line Driver  
Single-Ended-to-Differential Conversion  
High-Speed Differential Transmitter  
Coaxial to Twisted-Pair Converter  
Differential Pulse Amplifier  
Differential ADC Driver  
xDSL Applications  
Video and RF Signal Processing and Transmission

## Pin Configuration

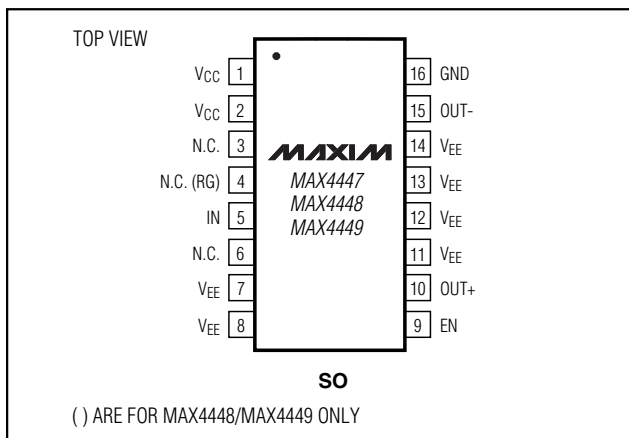

## Features

- ◆ 6500V/ $\mu$ s Slew Rate (MAX4449)
- ◆ Small-Signal Bandwidth
  - 430MHz (MAX4447)
  - 330MHz (MAX4448)
  - 400MHz (MAX4449)
- ◆ 200MHz 0.1dB Gain Flatness (MAX4447)
- ◆ 130mA Output Drive Current
- ◆ +2V/V Internally Fixed Gain (MAX4447)
- ◆ External Gain Selection
  - $\geq +2$ V/V (MAX4448)
  - $\geq +5$ V/V (MAX4449)
- ◆ -78dB SFDR at 100kHz
- ◆ Low Differential Gain/Phase: 0.01%/0.02°
- ◆ Ultra-Low Noise: 23nV/ $\sqrt{\text{Hz}}$  at  $f_{\text{IN}} = 1$ MHz
- ◆ 8ns Settling Time to 0.1%

## Ordering Information

PART	TEMP. RANGE	PIN-PACKAGE
MAX4447ESE	-40°C to +85°C	16 Narrow SO
MAX4448ESE	-40°C to +85°C	16 Narrow SO
MAX4449ESE	-40°C to +85°C	16 Narrow SO

## Typical Operating Circuit

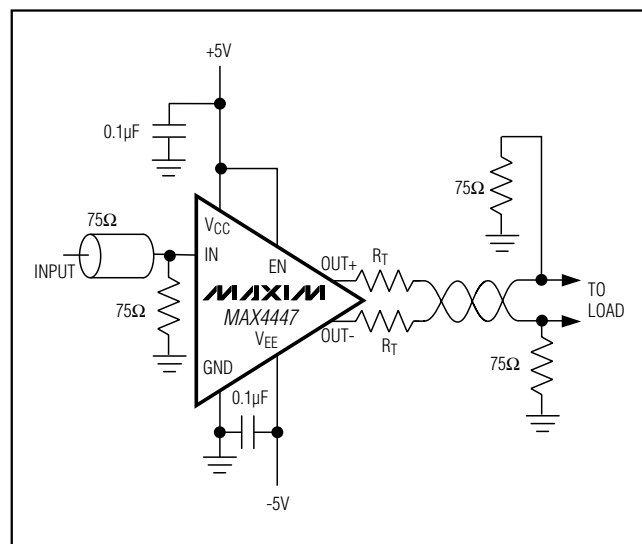

# 6500V/ $\mu$ s, Wideband, High-Output-Current, Single-Ended-to-Differential Line Drivers with Enable

## ABSOLUTE MAXIMUM RATINGS

VCC to VEE .....+12V  
 Voltage on IN, EN, OUT+, OUT-, RG.....(VEE - 0.3V) to (VCC + 0.3V)  
 Output Short-Circuit Duration to GND .....Indefinite  
 Continuous Power Dissipation (TA = +70°C)  
 16-Pin Narrow SO (derate 20mW/°C above +70°C) ..1600mW

Operating Temperature Range .....-40°C to +85°C  
 Storage Temperature Range .....-65°C to +150°C  
 Lead Temperature (soldering, 10s) .....+300°C

Stresses beyond those listed under "Absolute Maximum Ratings" may cause permanent damage to the device. These are stress ratings only, and functional operation of the device at these or any other conditions beyond those indicated in the operational sections of the specifications is not implied. Exposure to absolute maximum rating conditions for extended periods may affect device reliability.

## DC ELECTRICAL CHARACTERISTICS

(VCC = +5V, VEE = -5V, VEN  $\geq$  2V, VOUT = VOUT+ - VOUT-, RL =  $\infty$ , TA = TMIN to TMAX, unless otherwise noted. Typical values are at TA = +25°C.)

PARAMETER	SYMBOL	CONDITIONS	MIN	TYP	MAX	UNITS
Operating Supply Voltage Range	VCC	VCC guaranteed by PSRR test	4.5		5.5	V
	VEE	VEE guaranteed by PSRR test	-5.5		-4.5	
Input Voltage Range	VIN	Guaranteed by gain-error test	-6/AV		+6/AV	V
Input Offset Voltage	VOS	VIN = 0		1.3	50	mV
Input Offset Voltage Temperature Coefficient	TCVOS	VIN = 0		25		$\mu$ V/°C
Input Bias Current	IB	VIN = 0		7	45	$\mu$ A
Input Resistance	RIN	-3.0V $\leq$ VIN $\leq$ 3.0V		50		k $\Omega$
Gain	AV	-6V $\leq$ VOUT $\leq$ 6V	MAX4447	2		V/V
			MAX4448/MAX4449 (Note 1)	$2 \times (1+300/R_G)$		
Gain Error		-6V $\leq$ VOUT $\leq$ 6V	MAX4447	0.1	2	%
			MAX4448/MAX4449	-0.3	5	
Gain Drift		VOUT = 0	MAX4447	-0.002		%/°C
			MAX4448/MAX4449	0.01		
Output Voltage Swing	VOUT	RL = 100 $\Omega$ between OUT+ and OUT-	$\pm$ 6.3	$\pm$ 7.4		V
		RL = 50 $\Omega$ between OUT+ and OUT-	$\pm$ 5.2	$\pm$ 6.2		
Output Current Drive	IOUT	RL = 20 $\Omega$ between OUT+ and OUT-	90	130		mA
Output Short-Circuit Current	ISC	Short circuit to GND		140		mA
Power-Supply Rejection Ratio	PSRR	VS = $\pm$ 4.5V to $\pm$ 5.5V	53	75		dB
Output Leakage Current	IOUT(OFF)	VEN = 0, VOUT+ = VOUT- = 3.15V or -3.15V		4	30	$\mu$ A
EN Logic Low Threshold	VIL				0.8	V
EN Logic High Threshold	VIH		2			V
EN Logic Input Low Current	IIL	VEN = 0		-2.5	10	$\mu$ A
EN Logic Input High Current	IIH	VEN = 5V		0.8	10	$\mu$ A
Quiescent Current	IQ	VIN = 0, VEN $\geq$ VIH		46	55	mA
		VIN = 0, VEN $\leq$ VIL		3.2	5.5	

# 6500V/ $\mu$ s, Wideband, High-Output-Current, Single-Ended-to-Differential Line Drivers with Enable

MAX4447/MAX4448/MAX4449

## AC ELECTRICAL CHARACTERISTICS

( $V_{CC} = +5V$ ,  $V_{EE} = -5V$ ,  $R_L = 100\Omega$  between  $OUT+$  and  $OUT-$ ,  $A_{vCL} = +2V/V$  for MAX4447/MAX4448,  $A_{vCL} = +5V/V$  for MAX4449,  $V_{OUT} = V_{OUT+} - V_{OUT-}$ ,  $T_A = +25^\circ C$ , unless otherwise noted.)

PARAMETER	SYMBOL	CONDITIONS	MIN	TYP	MAX	UNITS
Small-Signal -3dB Bandwidth	BW <sub>SS</sub>	$V_{OUT} = 100mVp-p$	MAX4447	430		MHz
			MAX4448	330		
			MAX4449	400		
Large-Signal -3dB Bandwidth	BW <sub>LS</sub>	$V_{OUT} = 8Vp-p$	MAX4449	250		MHz
			MAX4447	250		
		$V_{OUT} = 4Vp-p$	MAX4448	260		
			MAX4449	320		
		$V_{OUT} = 2Vp-p$	MAX4447	285		
			MAX4448	310		
0.1dB Gain Flatness		$V_{OUT} = 100mVp-p$	MAX4447	200		MHz
			MAX4448	40		
			MAX4449	140		
Slew Rate (Note 2)	SR	$V_{OUT} = 8V$ step	MAX4447	5700		$V/\mu s$
			MAX4448	4300		
			MAX4449	6500		
		$V_{OUT} = 4V$ step	MAX4447	3000		
			MAX4448	3000		
			MAX4449	3700		
		$V_{OUT} = 2V$ step	MAX4447	1700		
			MAX4448	1900		
			MAX4449	1800		
Rise Time (Note 2)	$t_{RISE}$	$V_{OUT} = 8V$ step	MAX4447	670		ps
			MAX4448	1030		
			MAX4449	850		
		$V_{OUT} = 4V$ step	MAX4447	720		
			MAX4448	820		
			MAX4449	660		
		$V_{OUT} = 2V$ step	MAX4447	720		
			MAX4448	520		
			MAX4449	740		

# 6500V/ $\mu$ s, Wideband, High-Output-Current, Single-Ended-to-Differential Line Drivers with Enable

## AC ELECTRICAL CHARACTERISTICS (continued)

( $V_{CC} = +5V$ ,  $V_{EE} = -5V$ ,  $R_L = 100\Omega$  between  $OUT+$  and  $OUT-$ ,  $A_{VCL} = +2V/V$  for MAX4447/MAX4448,  $A_{VCL} = +5V/V$  for MAX4449,  $V_{OUT} = V_{OUT+} - V_{OUT-}$ ,  $T_A = +25^\circ C$ , unless otherwise noted.)

PARAMETER	SYMBOL	CONDITIONS	MIN	TYP	MAX	UNITS
Fall Time (Note 2)	$t_{FALL}$	$V_{OUT} = 8V$ step	MAX4447	1100		ps
			MAX4448	900		
			MAX4449	900		
		$V_{OUT} = 4V$ step	MAX4447	900		
			MAX4448	810		
			MAX4449	780		
		$V_{OUT} = 2V$ step	MAX4447	800		
			MAX4448	770		
			MAX4449	660		
Settling Time		Settle to 0.1%, $V_{OUT} = 2V$ step		8		ns
Spurious-Free Dynamic Range	SFDR	$V_{OUT} = 2V_{p-p}$	$f_C = 100kHz$	-78		dBc
			$f_C = 5MHz$	-78		
			$f_C = 20MHz$	-62		
			$f_C = 100MHz$	-46		
2nd Harmonic Distortion		$V_{OUT} = 2V_{p-p}$	$f_C = 100kHz$	-78		dBc
			$f_C = 5MHz$	-78		
			$f_C = 20MHz$	-62		
			$f_C = 100MHz$	-46		
3rd Harmonic Distortion		$V_{OUT} = 2V_{p-p}$	$f_C = 100kHz$	-86		dBc
			$f_C = 5MHz$	-86		
			$f_C = 20MHz$	-71		
			$f_C = 100MHz$	-54		
Differential Phase Error	DP	NTSC, $R_L = 150\Omega$		0.02		degrees
Differential Gain Error	DG	NTSC, $R_L = 150\Omega$		0.01		%
Input Noise Voltage Density	$e_N$	$f = 1MHz$ (Note 3)		24		$nV/\sqrt{Hz}$
Input Noise Current Density	$i_N$	$f = 1MHz$		1.8		$pA/\sqrt{Hz}$
Output Impedance	$Z_{OUT\pm}$	$f = 10MHz$ , each output to ground		1.0		$\Omega$
Enable Time		$V_{IN} = 1V$ , $V_{OUT}$ settle to within 1%		55		ns
Disable Time		$V_{IN} = 1V$ , $V_{OUT}$ settle to within 1%		0.4		$\mu s$
Power-Up Time	$t_{ON}$	$V_{IN} = 1V$ , $V_{OUT}$ settle to within 1%		0.08		$\mu s$
Power-Down Time	$t_{OFF}$	$V_{IN} = 1V$ , $V_{OUT}$ settle to within 1%		0.5		$\mu s$

**Note 1:**  $R_G$  is the gain resistor. See Figure 1.

**Note 2:** Input step voltage has <100ps rise (fall) time. Measured at the output from 10% to 90% (90% to 10%) levels.

**Note 3:** Includes the current noise contribution through the on-die feedback resistor.

# 6500V/ $\mu$ s, Wideband, High-Output-Current, Single-Ended-to-Differential Line Drivers with Enable

## Typical Operating Characteristics

( $V_{CC} = +5V$ ,  $V_{EE} = -5V$ ,  $V_{EN} = +5V$ ,  $V_{OUT} = V_{OUT+} - V_{OUT-}$ ,  $R_L = 100\Omega$  between  $OUT+$  and  $OUT-$ ,  $A_v = +2V/V$  for MAX4447/MAX4448,  $A_v = +5V/V$  for MAX4449,  $T_A = +25^\circ C$ , unless otherwise noted.)

MAX4447/MAX4448/MAX4449

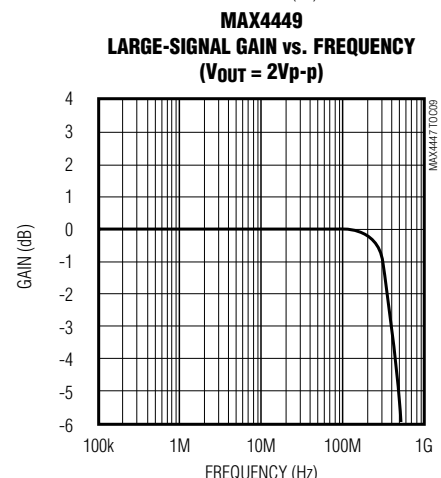
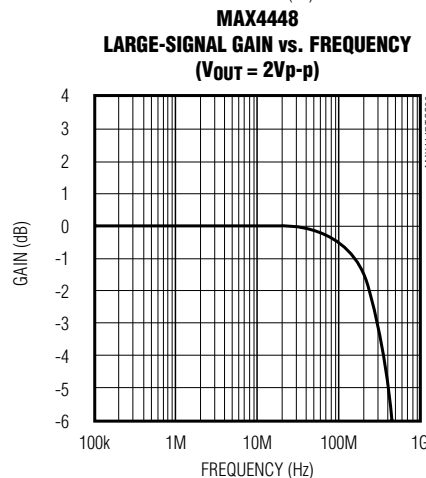
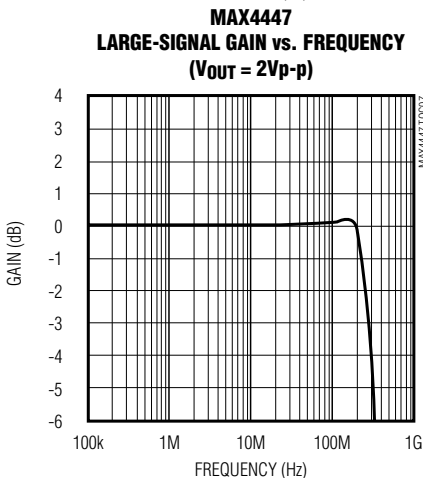
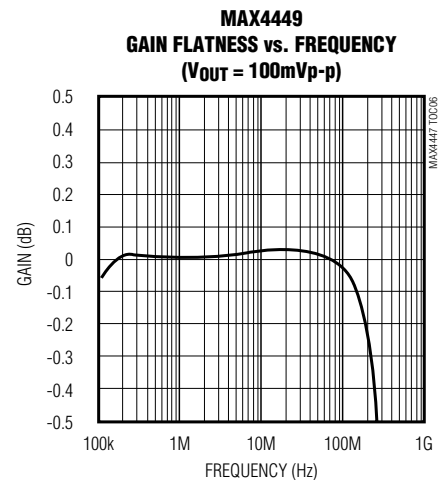
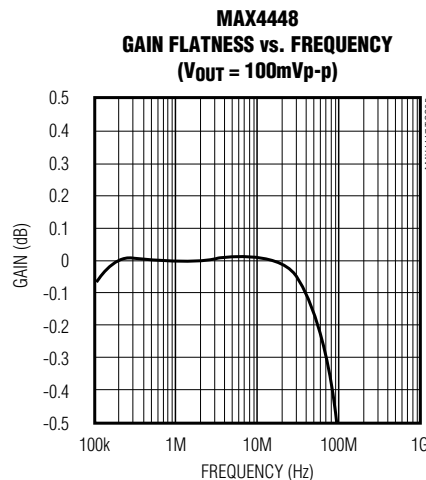
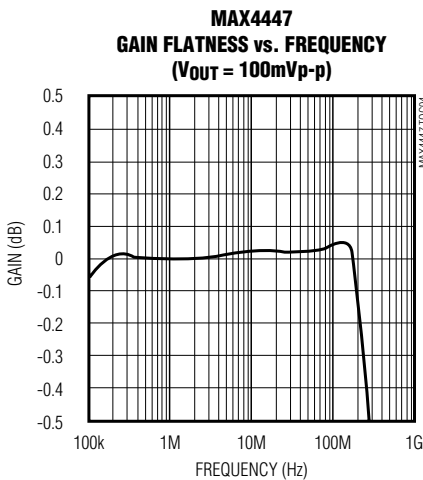
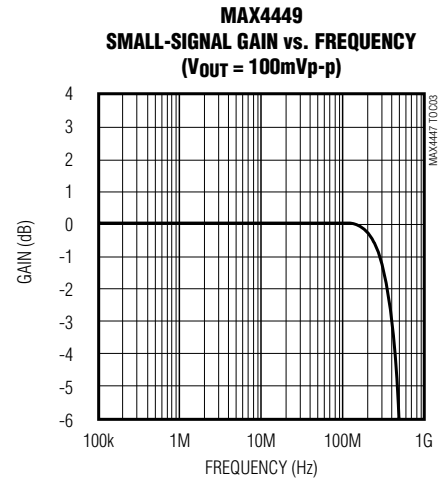
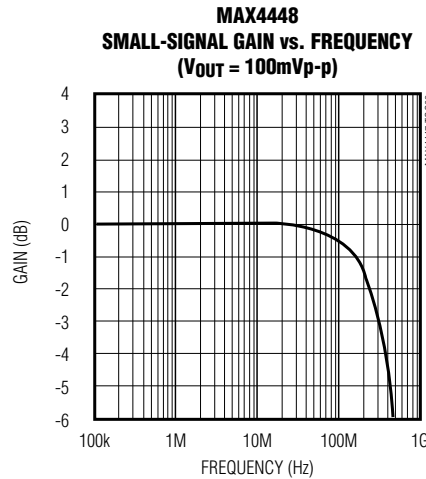
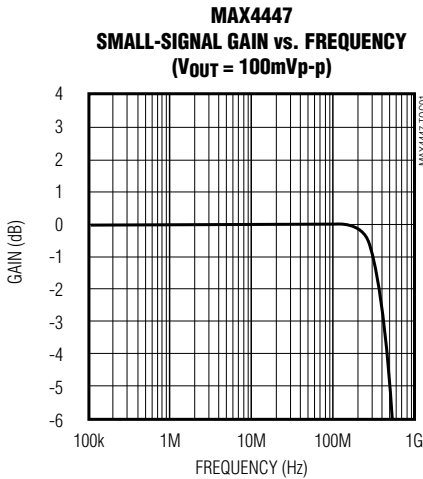

# 6500V/ $\mu$ s, Wideband, High-Output-Current, Single-Ended-to-Differential Line Drivers with Enable

## Typical Operating Characteristics (continued)

( $V_{CC} = +5V$ ,  $V_{EE} = -5V$ ,  $V_{EN} = +5V$ ,  $V_{OUT} = V_{OUT+} - V_{OUT-}$ ,  $R_L = 100\Omega$  between  $OUT+$  and  $OUT-$ ,  $A_v = +2V/V$  for MAX4447/MAX4448,  $A_v = +5V/V$  for MAX4449,  $T_A = +25^\circ C$ , unless otherwise noted.)

**MAX4447**  
SMALL-SIGNAL GAIN vs. FREQUENCY  
( $V_{OUT} = 100mVp-p$ )

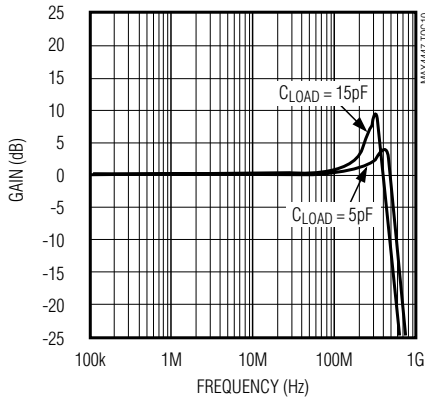

**MAX4448**  
SMALL-SIGNAL GAIN vs. FREQUENCY  
( $V_{OUT} = 100mVp-p$ )

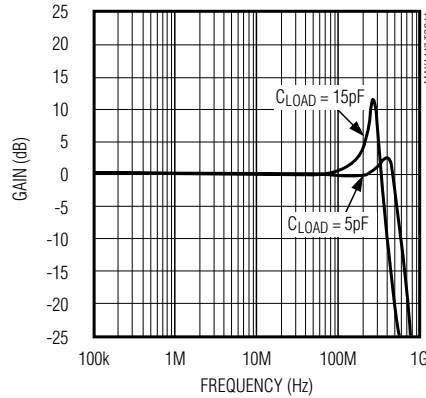

**MAX4449**  
SMALL-SIGNAL GAIN vs. FREQUENCY  
( $V_{OUT} = 100mVp-p$ )

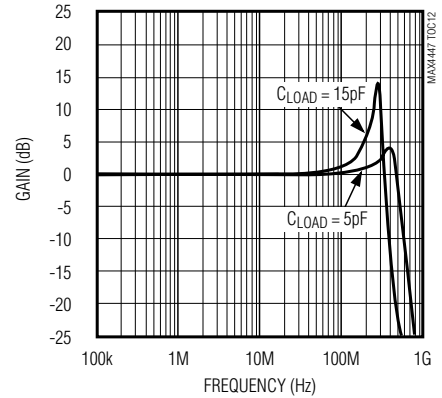

**MAX4447**  
SMALL-SIGNAL PULSE RESPONSE

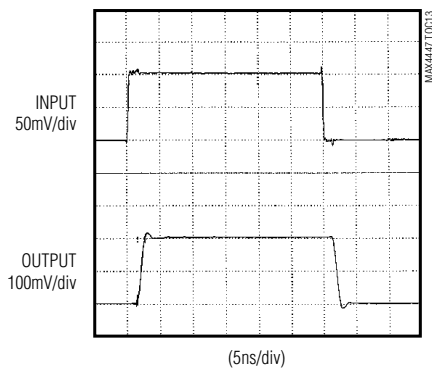

**MAX4448**  
SMALL-SIGNAL PULSE RESPONSE

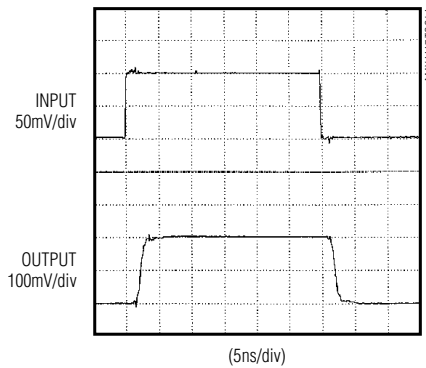

**MAX4449**  
SMALL-SIGNAL PULSE RESPONSE

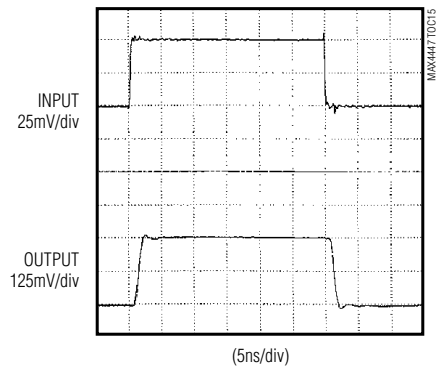

**MAX4447**  
LARGE-SIGNAL PULSE RESPONSE

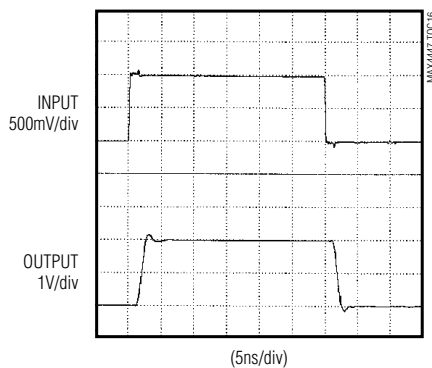

**MAX4448**  
LARGE-SIGNAL PULSE RESPONSE

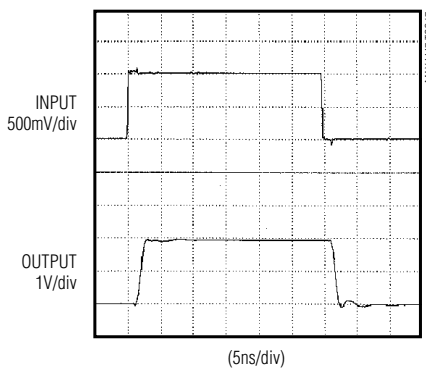

**MAX4449**  
LARGE-SIGNAL PULSE RESPONSE

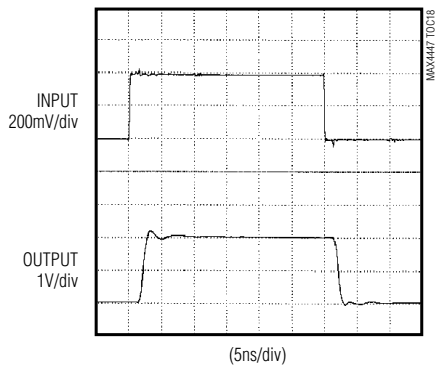

# 6500V/ $\mu$ s, Wideband, High-Output-Current, Single-Ended-to-Differential Line Drivers with Enable

## Typical Operating Characteristics (continued)

( $V_{CC} = +5V$ ,  $V_{EE} = -5V$ ,  $V_{EN} = +5V$ ,  $V_{OUT} = V_{OUT+} - V_{OUT-}$ ,  $R_L = 100\Omega$  between  $OUT+$  and  $OUT-$ ,  $A_V = +2V/V$  for MAX4447/MAX4448,  $A_V = +5V/V$  for MAX4449,  $T_A = +25^\circ C$ , unless otherwise noted.)

MAX4447/MAX4448/MAX4449

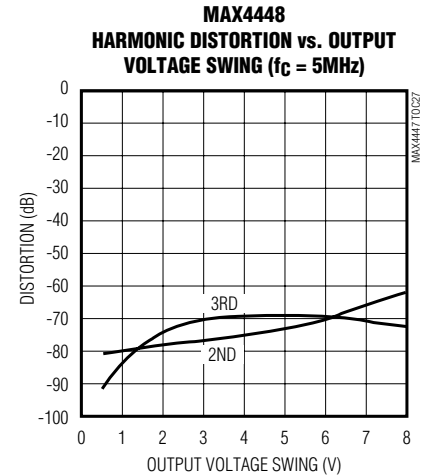
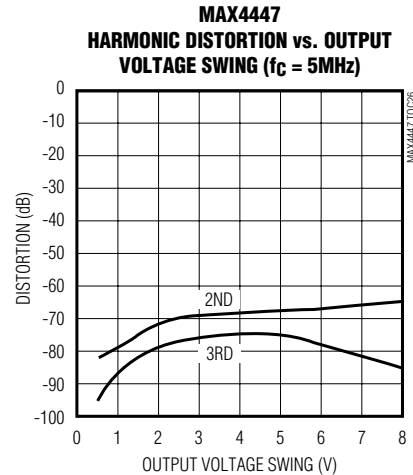
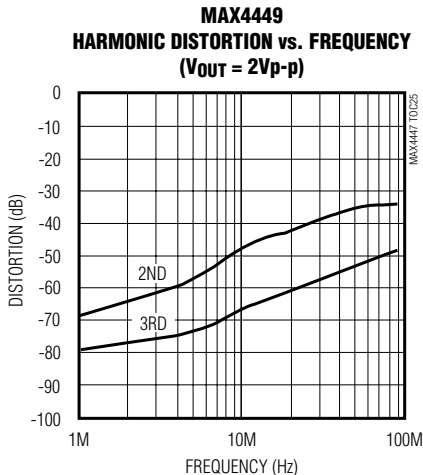
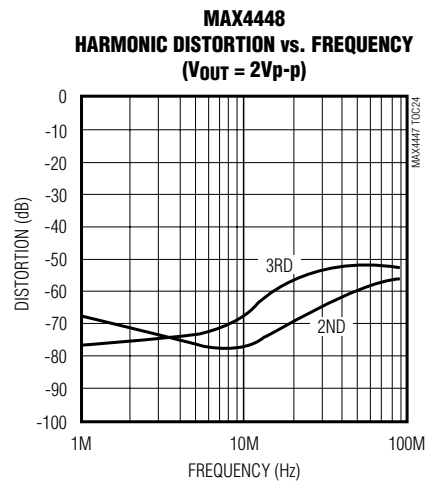
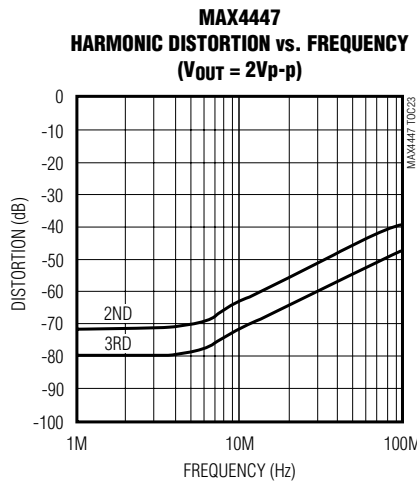
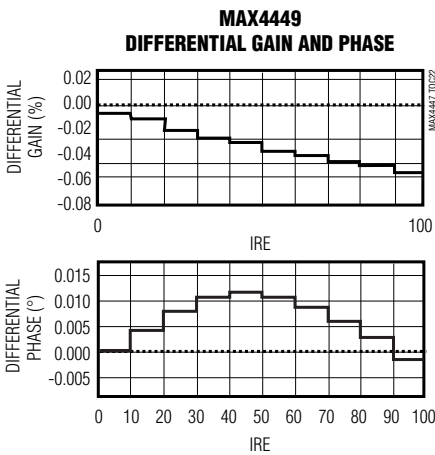
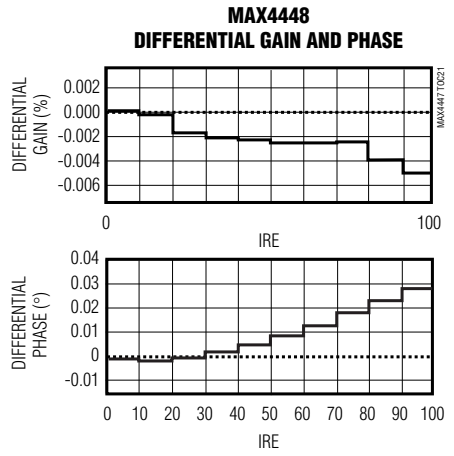
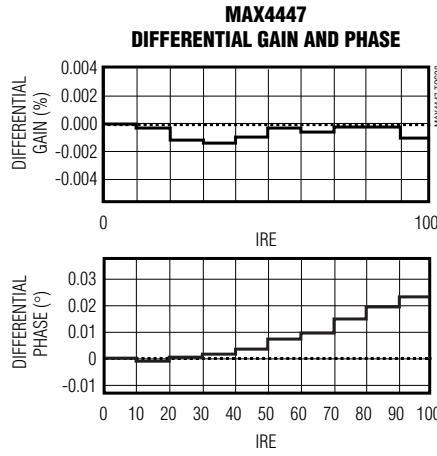
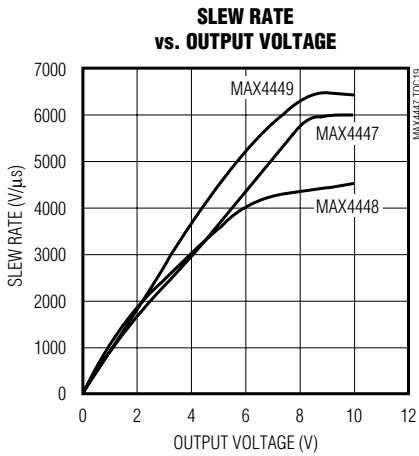

# 6500V/ $\mu$ s, Wideband, High-Output-Current, Single-Ended-to-Differential Line Drivers with Enable

## Typical Operating Characteristics (continued)

( $V_{CC} = +5V$ ,  $V_{EE} = -5V$ ,  $V_{EN} = +5V$ ,  $V_{OUT} = V_{OUT+} - V_{OUT-}$ ,  $R_L = 100\Omega$  between  $OUT+$  and  $OUT-$ ,  $A_V = +2V/V$  for MAX4447/MAX4448,  $A_V = +5V/V$  for MAX4449,  $T_A = +25^\circ C$ , unless otherwise noted.)

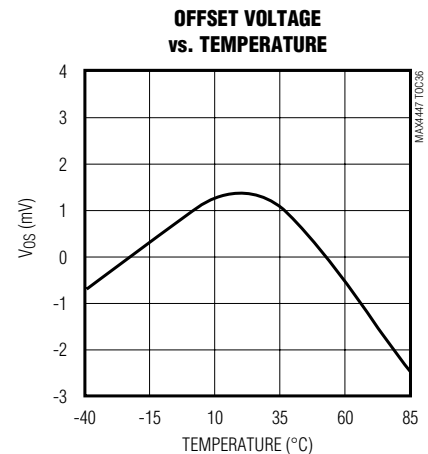
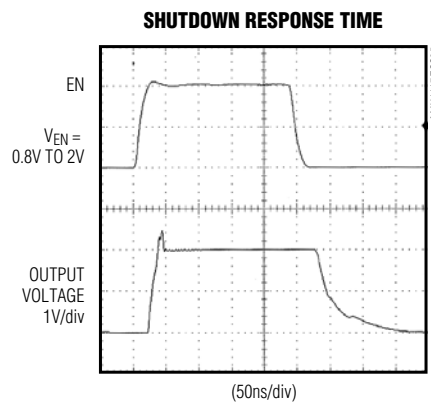
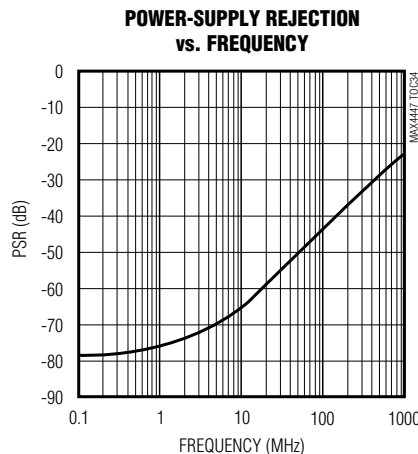
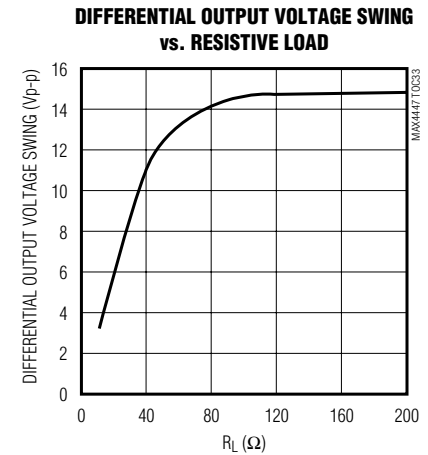
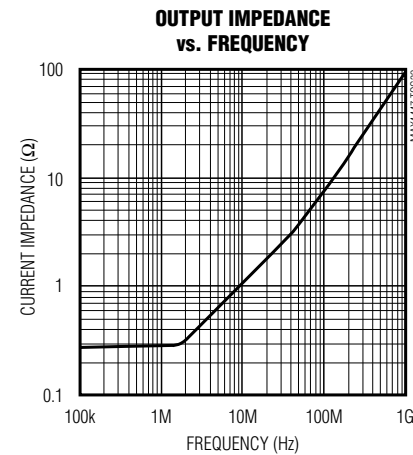
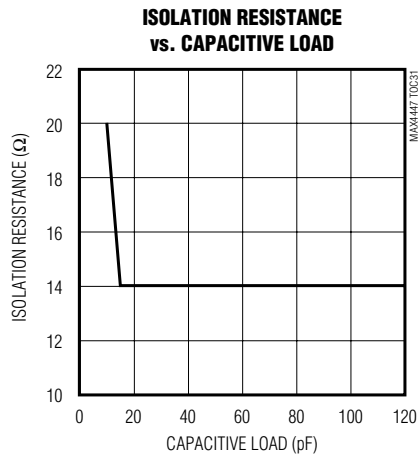
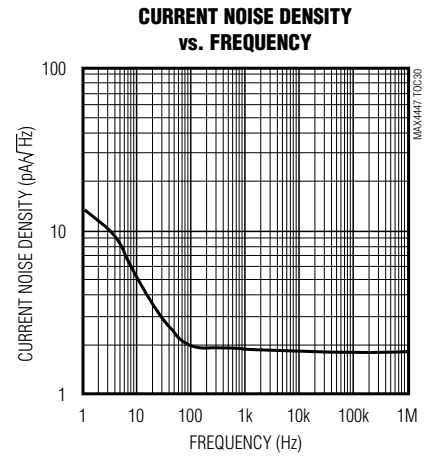
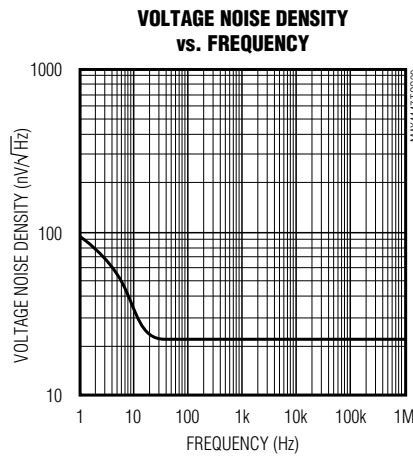
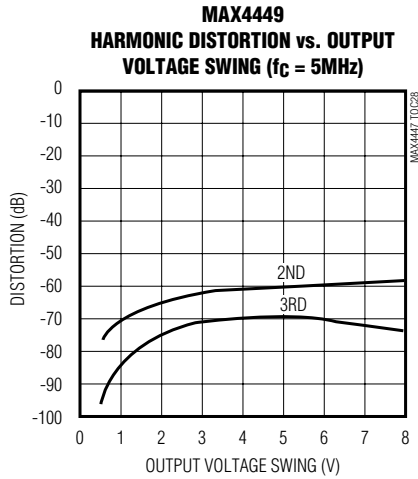



# 6500V/ $\mu$ s, Wideband, High-Output-Current, Single-Ended-to-Differential Line Drivers with Enable

## Typical Operating Characteristics (continued)

( $V_{CC} = +5V$ ,  $V_{EE} = -5V$ ,  $V_{EN} = +5V$ ,  $V_{OUT} = V_{OUT+} - V_{OUT-}$ ,  $R_L = 100\Omega$  between  $OUT+$  and  $OUT-$ ,  $A_V = +2V/V$  for MAX4447/MAX4448,  $A_V = +5V/V$  for MAX4449,  $T_A = +25^\circ C$ , unless otherwise noted.)

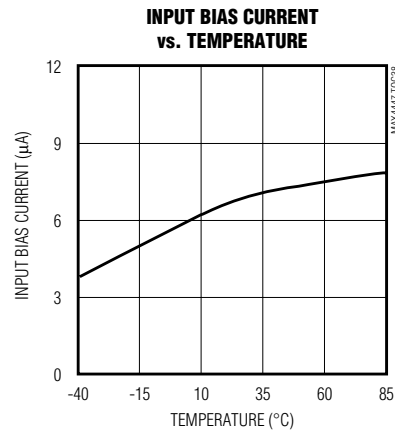
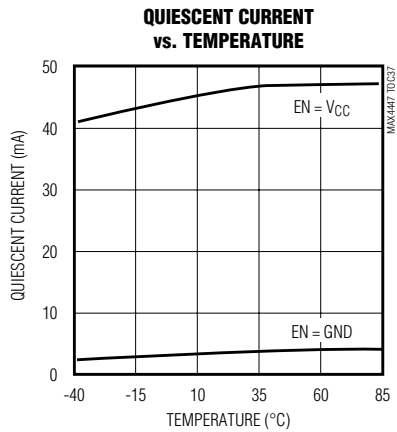

## Pin Description

PIN		NAME	FUNCTION
MAX4447	MAX4448 MAX4449		
1, 2	1, 2	$V_{CC}$	Positive Power Supply. Bypass with a 0.1 $\mu$ F capacitor to GND.
3, 4, 6	3, 6	N.C.	No Connection. Not internally connected. Connect to GND for best AC performance.
—	4	RG	Gain-Set Resistor. Connect gain-setting resistor from RG to GND.
5	5	IN	Amplifier Noninverting Input
7, 8, 11, 12, 13, 14	7, 8, 11, 12, 13, 14	$V_{EE}$	Negative Power-Supply Input. Bypass with a 0.1 $\mu$ F capacitor to GND.
9	9	EN	Active-High, TTL-Compatible, Enable Input. Connect to $V_{CC}$ for normal operation. Connect to GND for low-power operation.
10	10	OUT+	Positive Polarity Output
15	15	OUT-	Negative Polarity Output
16	16	GND	Ground

MAX4447/MAX4448/MAX4449

# 6500V/ $\mu$ s, Wideband, High-Output-Current, Single-Ended-to-Differential Line Drivers with Enable

## Detailed Description

The MAX4447/MAX4448/MAX4449 single-ended-to-differential converters are capable of transmitting high-speed signals such as T1 or xDSL over twisted-pair cable. Excellent gain and phase characteristics, along with low distortion, make these devices suitable for video and RF signal processing and transmission. These converters can be interfaced directly to some of Maxim's wireless products, such as the MAX2450/MAX2451.

The MAX4447/MAX4448/MAX4449 offer wide small-signal bandwidths of 430MHz, 330MHz, and 400MHz, respectively. Internally trimmed resistors minimize gain errors to under 2% over the full output range. Other features include a high slew rate up to 6500V/ $\mu$ s and high output current (130mA), which allow these amplifiers to be used in numerous high-speed communications applications.

## Applications Information

### Grounding and Bypassing

Use high-frequency design techniques when designing the PC board for the MAX4447/MAX4448/MAX4449:

- Use a multilayer board with one layer dedicated as the ground plane.
- Do not wire-wrap or use breadboards, due to high inductance.
- Avoid IC sockets, due to high parasitic capacitance and inductance.
- Bypass supplies with 0.1 $\mu$ F. Use surface-mount capacitors to minimize lead inductance.
- Keep signal lines as short and straight as possible. Do not make 90° turns; round all corners. Do not cross signals if possible.
- Ensure that the ground plane is free from voids.

### Output Short-Circuit Protection

Output short-circuit protection typically limits the current to 140mA when shorted to GND, thereby keeping the power dissipation under the absolute maximum power dissipating rating. However, when shorted to either supply, the short-circuit current can be significantly higher and cause damage to the device.

### Low-Power Enable Mode

The MAX4447/MAX4448/MAX4449 are disabled when EN goes low. This reduces supply current to only 3.2mA and places the outputs into a higher impedance.

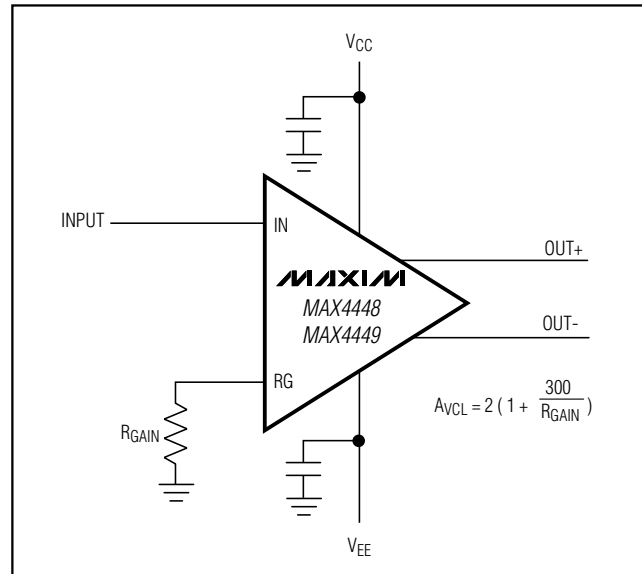

Figure 1. Setting the Amplifier Gain

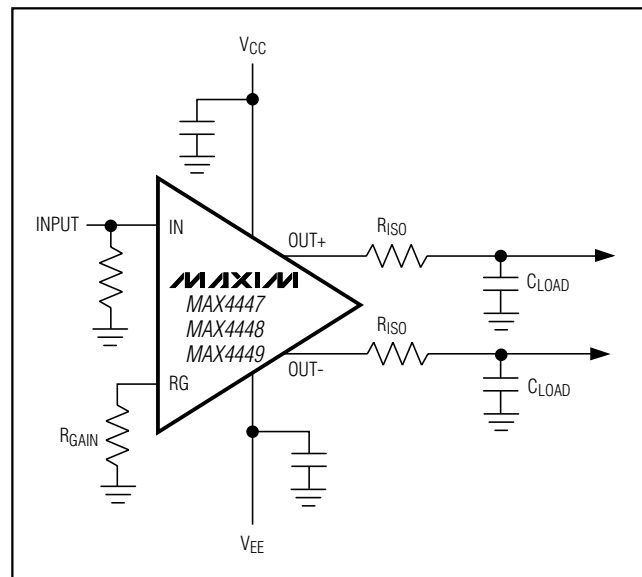

Figure 2. Using an Isolation Resistor for High Capacitive Loads

# 6500V/ $\mu$ s, Wideband, High-Output-Current, Single-Ended-to-Differential Line Drivers with Enable

MAX4447/MAX4448/MAX4449

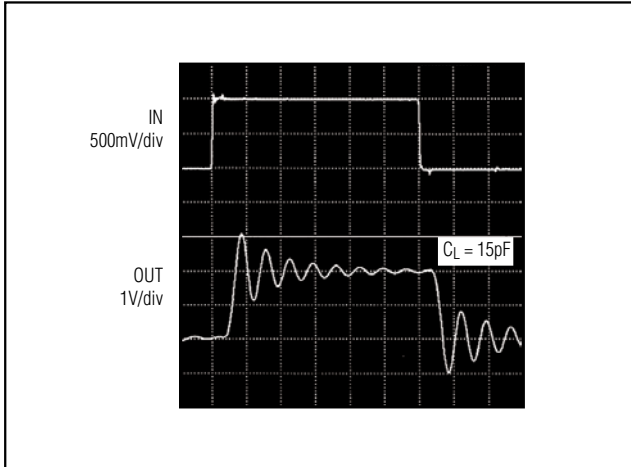

Figure 3. Capacitive-Loaded Output Step Response Without Isolation Resistor

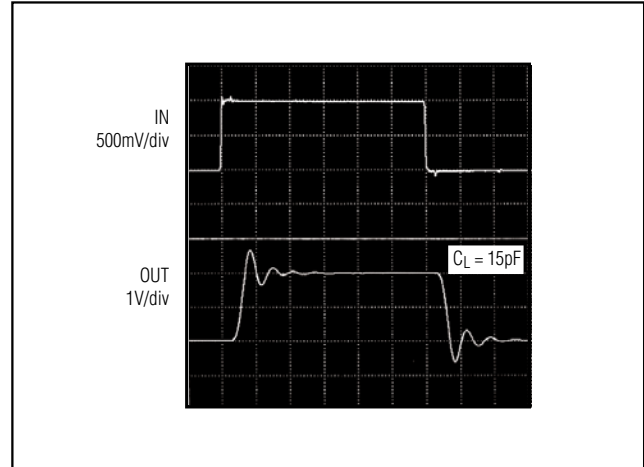

Figure 4. Capacitive-Loaded Output Step Response with 14 $\Omega$  Isolation Resistor

### Setting Gain

The MAX4448/MAX4449 are stable with minimum gain of +2V/V and +5V/V, respectively. An external resistor, R<sub>GAIN</sub>, connected between RG and GND sets the gain of these devices. Calculate the gain as follows:

$$\text{Gain} = 2 (1 + 300 / R_{\text{GAIN}})$$

R<sub>GAIN</sub> for the MAX4449 must be  $\leq 200\Omega$ .

### Driving Capacitive Loads

The MAX4447/MAX4448/MAX4449 are designed to drive capacitive loads. However, excessive capacitive loads may cause ringing or instability at the output as phase margin is reduced. Adding a small series isolation resistor at the output helps reduce the ringing but slightly increases gain error.

### Twisted-Pair Line Driver

The MAX4447/MAX4448/MAX4449 are well-suited to drive twisted-pair cables. The 24AWG telephone wire widely used produces losses at the higher frequencies. Compensate for these losses by increasing the gain slightly.

### Chip Information

TRANSISTOR COUNT: 291

# 6500V/ $\mu$ s, Wideband, High-Output-Current, Single-Ended-to-Differential Line Drivers with Enable

## Package Information

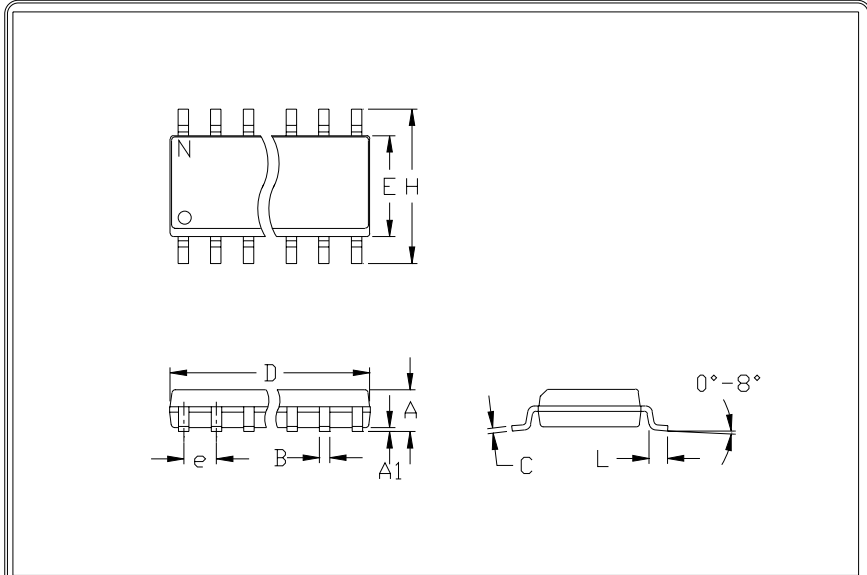

	INCHES		MILLIMETERS	
	MIN	MAX	MIN	MAX
A	0.053	0.069	1.35	1.75
A1	0.004	0.010	0.10	0.25
B	0.014	0.019	0.35	0.49
C	0.007	0.010	0.19	0.25
e	0.050		1.27	
E	0.150	0.157	3.80	4.00
H	0.228	0.244	5.80	6.20
h	0.010	0.020	0.25	0.50
L	0.016	0.050	0.40	1.27

	INCHES		MILLIMETERS		N	MS012
	MIN	MAX	MIN	MAX		
D	0.189	0.197	4.80	5.00	8	A
D	0.337	0.344	8.55	8.75	14	B
D	0.386	0.394	9.80	10.00	16	C

NOTES:

1. D&E DO NOT INCLUDE MOLD FLASH
2. MOLD FLASH OR PROTRUSIONS NOT TO EXCEED .15mm (.006")
3. LEADS TO BE COPLANAR WITHIN .102mm (.004")
4. CONTROLLING DIMENSION: MILLIMETER
5. MEETS JEDEC MS012-XX AS SHOWN IN ABOVE TABLE
6. N = NUMBER OF PINS



PACKAGE FAMILY OUTLINE: SOIC .150"



21-0041 A  
DOCUMENT CONTROL NUMBER REV

Maxim cannot assume responsibility for use of any circuitry other than circuitry entirely embodied in a Maxim product. No circuit patent licenses are implied. Maxim reserves the right to change the circuitry and specifications without notice at any time.

12 \_\_\_\_\_ **Maxim Integrated Products, 120 San Gabriel Drive, Sunnyvale, CA 94086 408-737-7600**